

ALPS MOCHA CURVE SOFA

359893

**BEFORE YOU START**











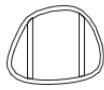



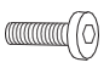

- Retain these instructions for future reference.
- When you are ready to start, make sure that you have the right tools, plenty of space and a clean, dry area for assembly.
- Unwrap all packaging materials and place the components on top of the carton box or on a clean floor to prevent it from scratching.
- Check the pack and make sure you have all the parts listed.
- Do not use power tools to construct this product.
- Ensure that this product is fully assembled as illustrated before use.

WARNINGS

- Do not stand on the product.
- This product should only be used on firm, level ground.
- Make sure the legs remain in contact with the ground.
- Keep small parts out of reach of children.
- Check all screws or bolts are tightened and inspect regularly.
- Do not tighten screws until fully assembled.
- Do not overtighten screws or bolts.
- Do not use this product if parts are missing, damaged or worn.
- This product is for domestic use only.
- This product is intended for a maximum weight of 110kg per seat. Do not exceed this weight.

ASSEMBLY INSTRUCTIONS

PARTS SUPPLIED

REF	DESCRIPTION	QUANTITY	ILLUSTRATION
A	Small Table Top	x1	
B	Large Table Top	x1	
C	Small Table Shelf	x1	
D	Large Table Shelf	x1	
E	Table Leg 1	x2	
F	Table Leg 2	x2	
G	Table Leg 3	x2	
H	Table Leg 4	x2	
I	Bolt (M6x20L)	x24	
J	Metal Washer (6.5)	x24	
K	Plastic Bolt Cap (M6)	x24	
L	Small Table Glass	x1	
M	Large Table Glass	x1	
N	Allen Key	x1	
O	"U" Clip	x2	
P	Seat Cushion	x2	
Q	Back Cushion	x6	

ASSEMBLY IMAGES & STEPS

Step 1

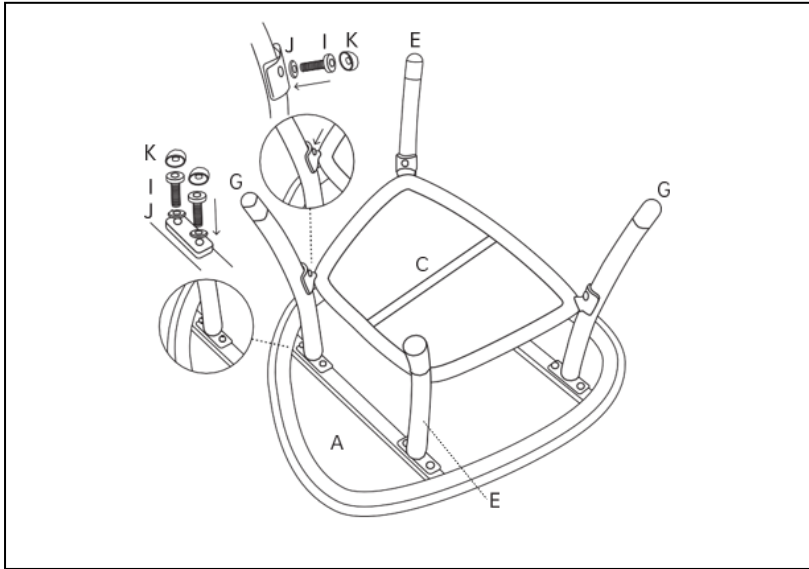

Use bolts (I) and washers (J) to connect Table Leg 1 (E) x2 and Table Leg 3 (G) x2, to Small Table Shelf (C) with Allen Key (N). Note each leg goes in the diagonally opposite corner from its partner. Leave bolts loose until after the next step.

Now use bolts (I) and washers (J) to connect each leg to Small Table Top (A). Tighten all bolts with Allen Key (N) and add Plastic Bolt Cap (K) to each bolt.

Turn the assembled table onto its feet and place Small Table Glass (L) on top of suction cups.

Step 2

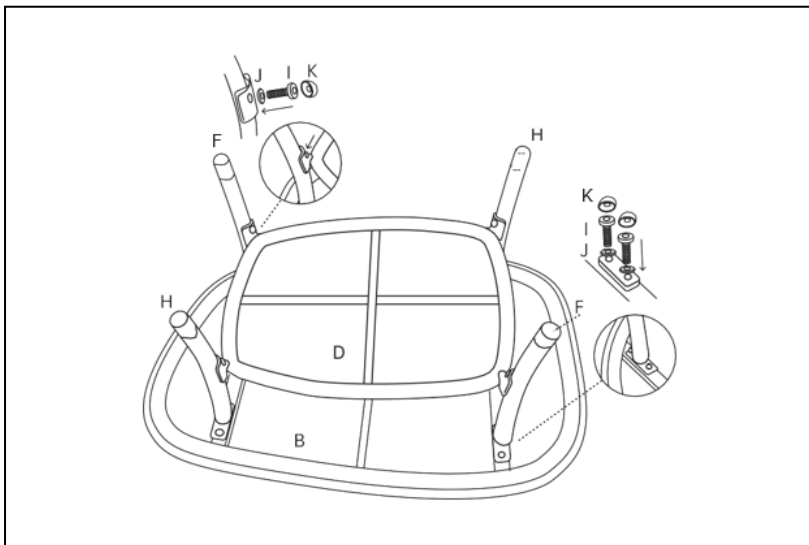

Use bolts (I) and washers (J) to connect Table Leg 2 (F)x2 and Table Leg 4 (H) x2 to Large Table Shelf (D) with Allen Key (N). Note each leg goes in the diagonally opposite corner from its partner. Leave bolts loose until after the next step.

Now use bolts (I) and washers (J) to connect each leg to Large Table Top (B). Tighten all bolts with Allen Key (N) and add Plastic Bolt Cap (K) to each bolt.

Turn the assembled table onto its feet and place Large Table Glass (M) on top of suction cups.

Step 3

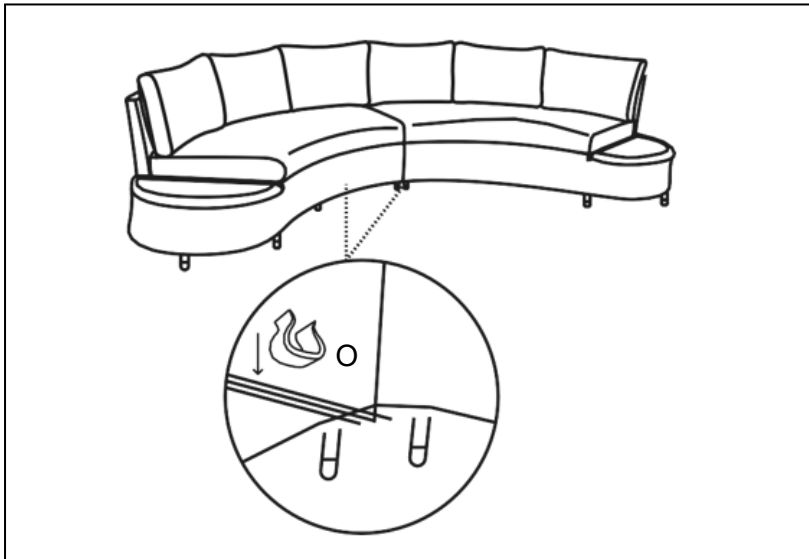

Ensure you are positioning both seat sections on a flat, stable surface. When you are happy with the location of furniture, attach “U” clips (O) to secure furniture together, before arranging your seat and back cushions.

CARE INSTRUCTIONS

- Please keep away from sources of extreme heat and naked flames, including any cushions or seat pads.
- Please note that synthetic weave product may sag under direct sunlight. This is a normal occurrence and the weave will return to its normal state upon cooling. To help reduce this occurrence, we recommend using a parasol where possible.
- Warm soapy water is recommended to clean the product. Please note that the cushions or seat pads must only be washed by sponge and left to dry naturally.
- Throughout the winter months, bring product indoors where possible or use a breathable furniture cover. Failure to do so may invalidate your warranty.