

## BOSTON SINGLE HANGING CHAIR

985013



## BEFORE YOU START











- Retain these instructions for future reference.
- When you are ready to start, make sure that you have plenty of space and a clean, dry area for assembly.
- Unwrap all packaging materials and place the components on a clean floor to prevent it from scratching.
- Check to make sure you have all the parts listed.
- Do not use power tools to construct this product.
- Ensure that this product is fully assembled as illustrated before use.















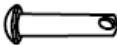

## WARNINGS

- Do not stand on the chair.
- This product is not a swing and is only to be used for its designated purpose.
- This product is intended for a maximum weight of 110kg per seat.
- Do not tighten the screws until fully assembled.
- Do not overtighten screws or bolts.
- It is recommended that two people assemble this product.
- Keep small parts out of reach of children.
- Do not use this product if parts are missing, damaged or worn.
- This product is for domestic use only.
- This product should only be used on firm, level ground.
- Periodically, inspect and tighten all fixings to ensure the product remains secure.
- Do not allow children to use this product without sufficient adult supervision.
- Do not use the chair without the safety tie in place.

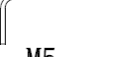
## ASSEMBLY INSTRUCTIONS

### PARTS SUPPLIED

REF	DESCRIPTION	ILLUSTRATION	QTY	REF	DESCRIPTION	ILLUSTRATION	QTY
A	Base pole 1		1	N	Bolt	 M8x20CM	5
B	Base pole 2		1	O	Washer	 M8	10
C	Support pole 1		1	P	Nut	 M8	5
D	Support pole 2		1	Q	Bolt	 M6x35CM	4
E	Seat 1		1	R	Washer	 M6	8

F	Seat 2		1	S	Nut	 M6	4
G	Cushion		1	T	Spanner	 M10	2
H	Bolt	 M10	1	U	Spanner	 M8	1
I	Nut	 M10	2	V	Spanner	 M6	1
J	Hanging pole		1	W	Allen key	 M4	1
K	Spring hook		1	X	Allen key	 M5	1
L	Chain		1	Y	Tie		1
M	C hook		1	Z	Screw cap		2
				Z1	Feet		6

## ASSEMBLY IMAGES & STEPS

Step 1

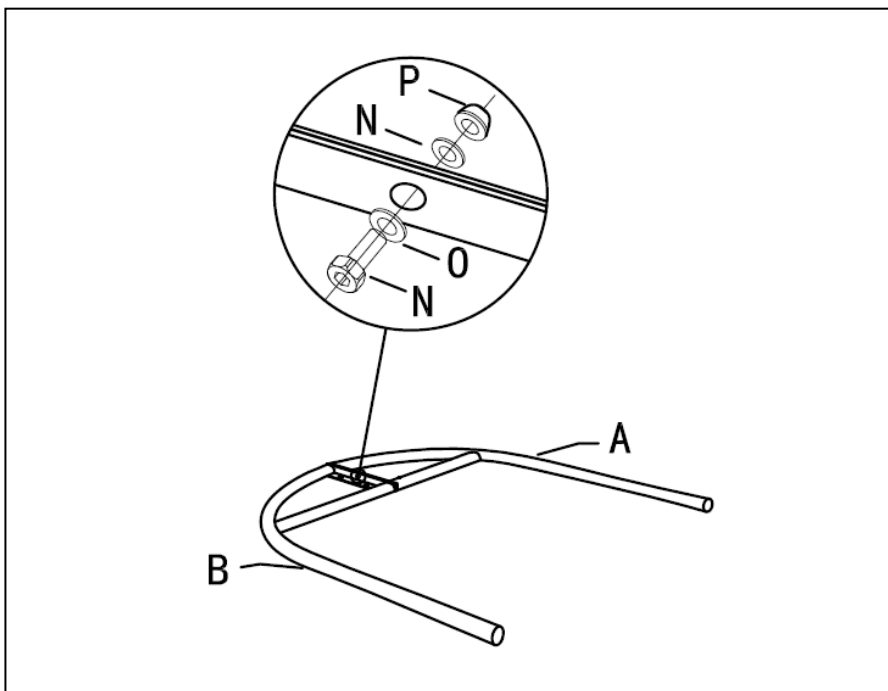

## Step 2

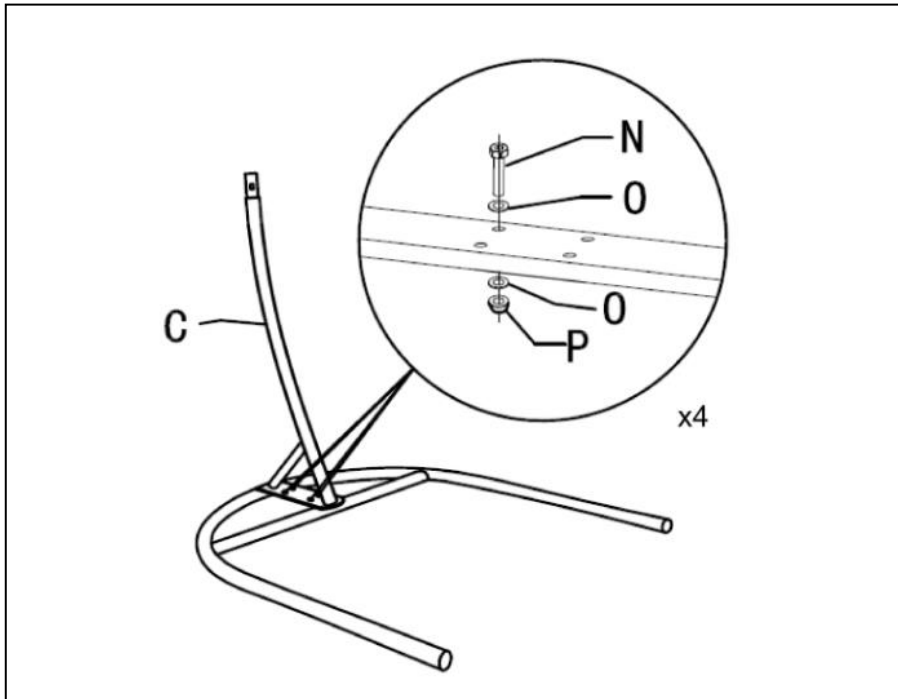

## Step 3

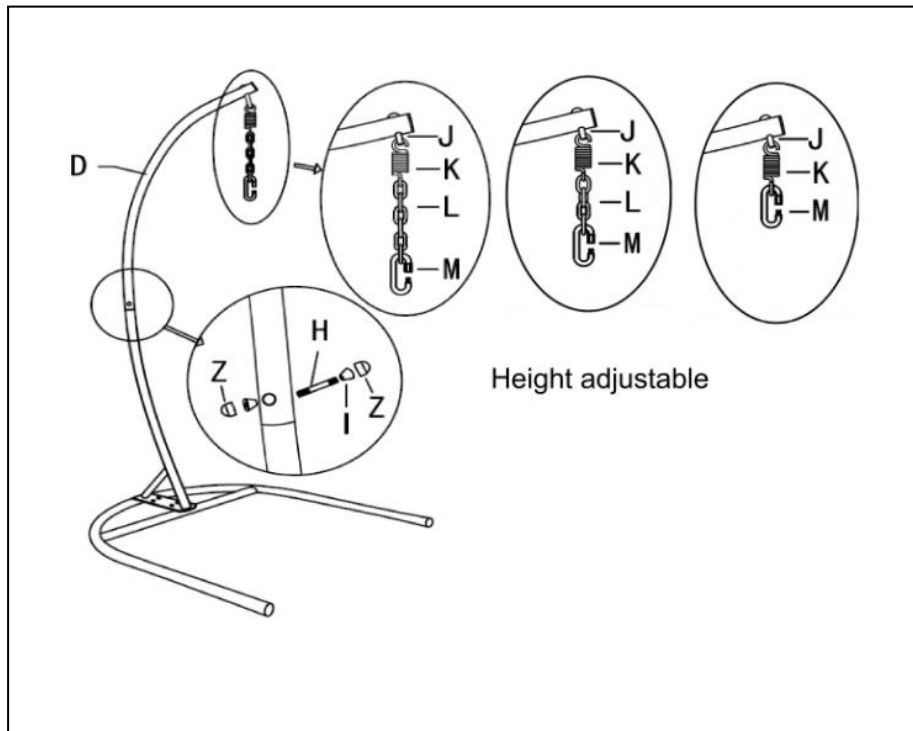

## Step 4

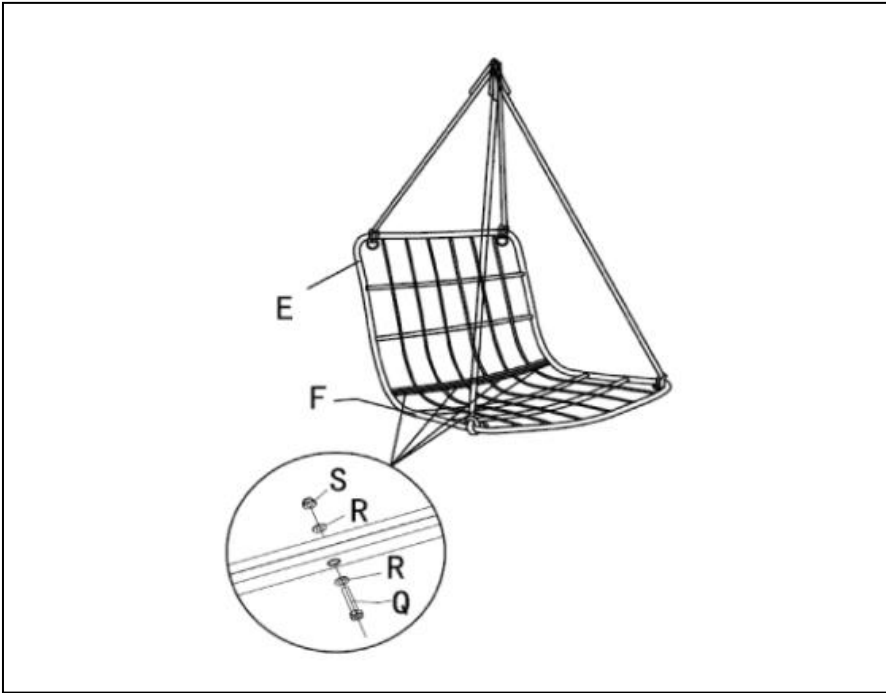

## Step 5

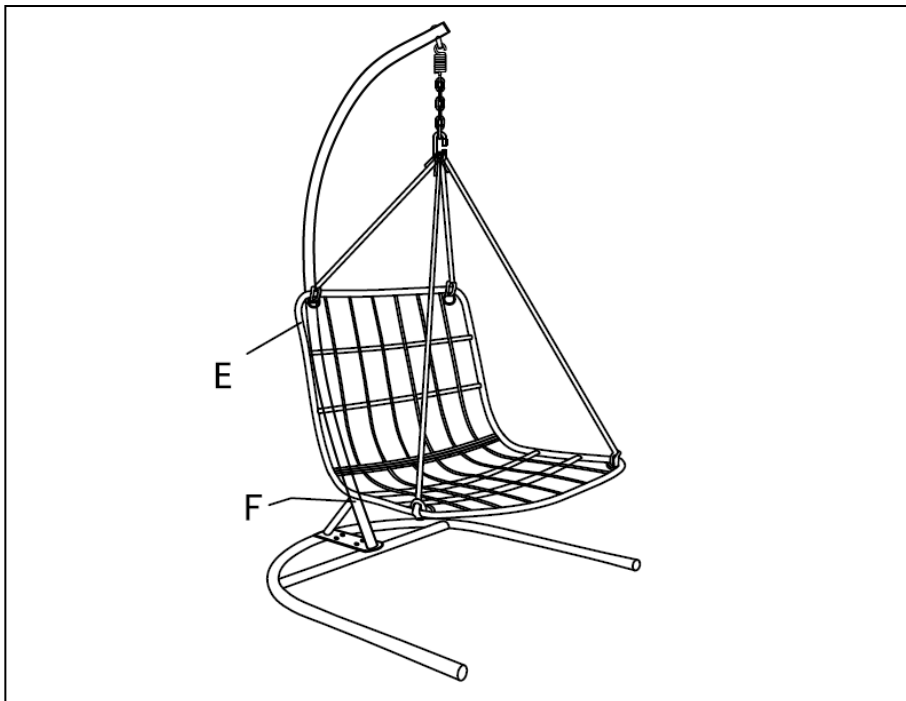

## Step 6

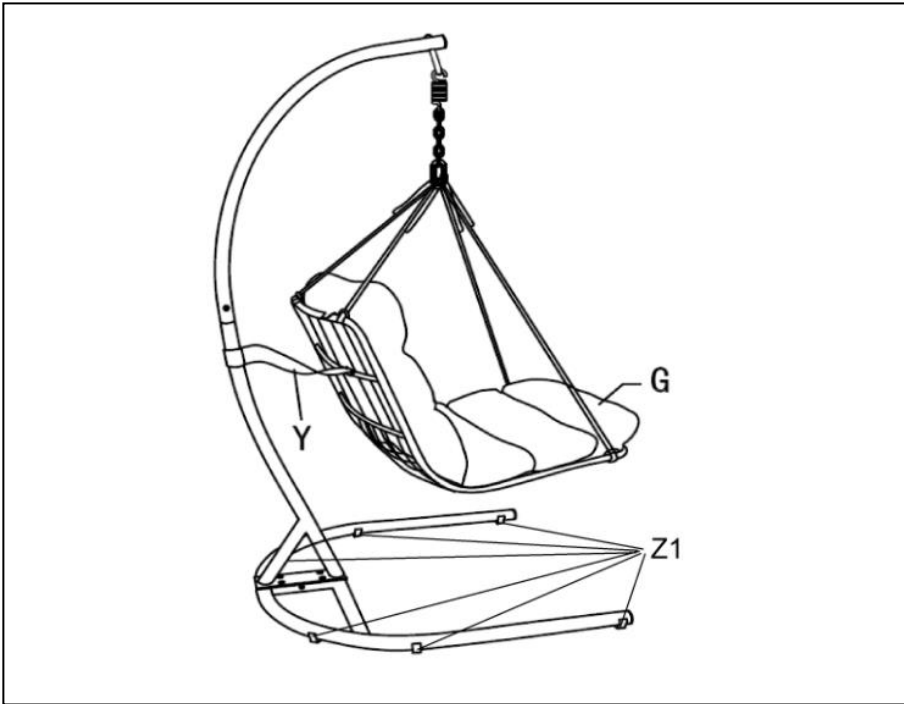

## CARE INSTRUCTIONS

- To clean, wipe with a sponge and warm soapy water, then wipe with a dry, clean cloth. Do not use solvent-based cleaners or detergents as they can bleach or damage the product.
- Never use a pressure hose or washer to clean the product. Never use scourers, abrasives or chemical cleaners.
- The pole surface is powder coated, do not use a wire brush when removing dirt from this item as it may damage the paint leaving the surface open to corrosion.
- Please note, the cushions are **not** waterproof and **should not** be left out in the rain. Please store the cushions in a cool, dry place when not in use.
- Store the furniture in a cool, dry place. Ensure that the furniture is clean and dry before putting into storage. Do NOT put the product in a plastic or other non-permeable material as this creates moisture.
- We recommend the use of a furniture cover when product not in use.
- Keep the egg chair away from fireworks and other flammable materials.
- Please keep away from sources of extreme heat and naked flames.
- The warranty does not cover accidental damage/neglect or general wear and tear.

---

## CONTACT

---

CUSTOMER SERVICES - EMAIL: [CUSTOMER.SERVICE@DOBBIES.COM](mailto:CUSTOMER.SERVICE@DOBBIES.COM). TELEPHONE NUMBER: 0131 561 6406 OR CONTACT YOUR LOCAL STORE.  
DOBBIES GARDEN CENTRES LTD, MELVILLE NURSERY, LASSWADE, MIDLOTHIAN, EH18 1AZ