

BOSTON LOUNGER 981885

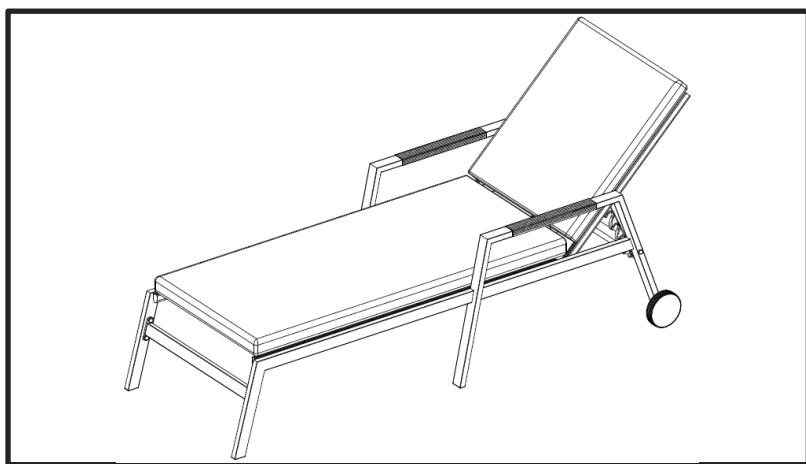











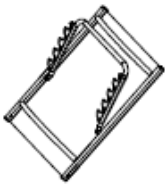

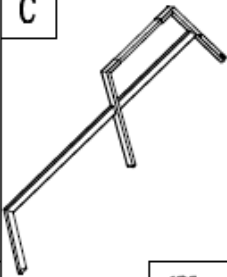
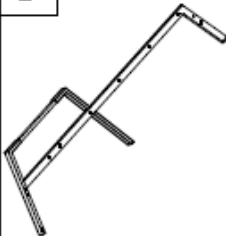

BEFORE YOU START

- Retain these instructions for future reference.
- When you are ready to start, make sure that you have the right tools, plenty of space and a clean, dry area for assembly.
- Unwrap all packaging materials and place the components on top of the carton box or on a clean floor to prevent it from scratching.
- Check the pack and make sure you have all the parts listed.
- Ensure that this product is fully assembled as illustrated before use.

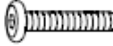
WARNINGS

- Do not stand on the lounger or allow children to play on or around the lounger.
- This product should only be used on firm, level ground.
- Make sure the legs remain in contact with the ground.
- Keep small parts out of reach of children.
- Do not use this product if parts are missing, damaged or worn.
- This product is for domestic use only.
- Take care when sitting on the product as placing weight on one end/side may cause the lounger to tip over.
- Take care when adjusting the back position, to ensure that you do not trap or pinch your fingers.
- Make sure the back is locked in position before using the lounger.
- Each seat is intended for a maximum weight of 110kg. Do not exceed this weight.

PART LIST

<p>A</p>  <p>1PC</p>	<p>B</p>  <p>1PC</p>	<p>C</p>  <p>1PC</p>	<p>D</p>  <p>1PC</p>	<p>E</p>  <p>1PC</p>	<p>F</p>  <p>1PC</p>
<p>G</p>  <p>1PC</p>	<p>H</p>  <p>2PCS</p>				
<p>I</p>  <p>M6X20 6PCS</p>	<p>J</p>  <p>M6X35 12PCS</p>	<p>K</p>  <p>M6X55 2PCS</p>	<p>L</p>  <p>2PCS</p>	<p>M</p>  <p>22PCS</p>	<p>N</p>  <p>2PCS</p>
<p>O</p>  <p>M6X12 2PCS</p>	<p>P</p>  <p>1X</p>				

ASSEMBLY INSTRUCTIONS

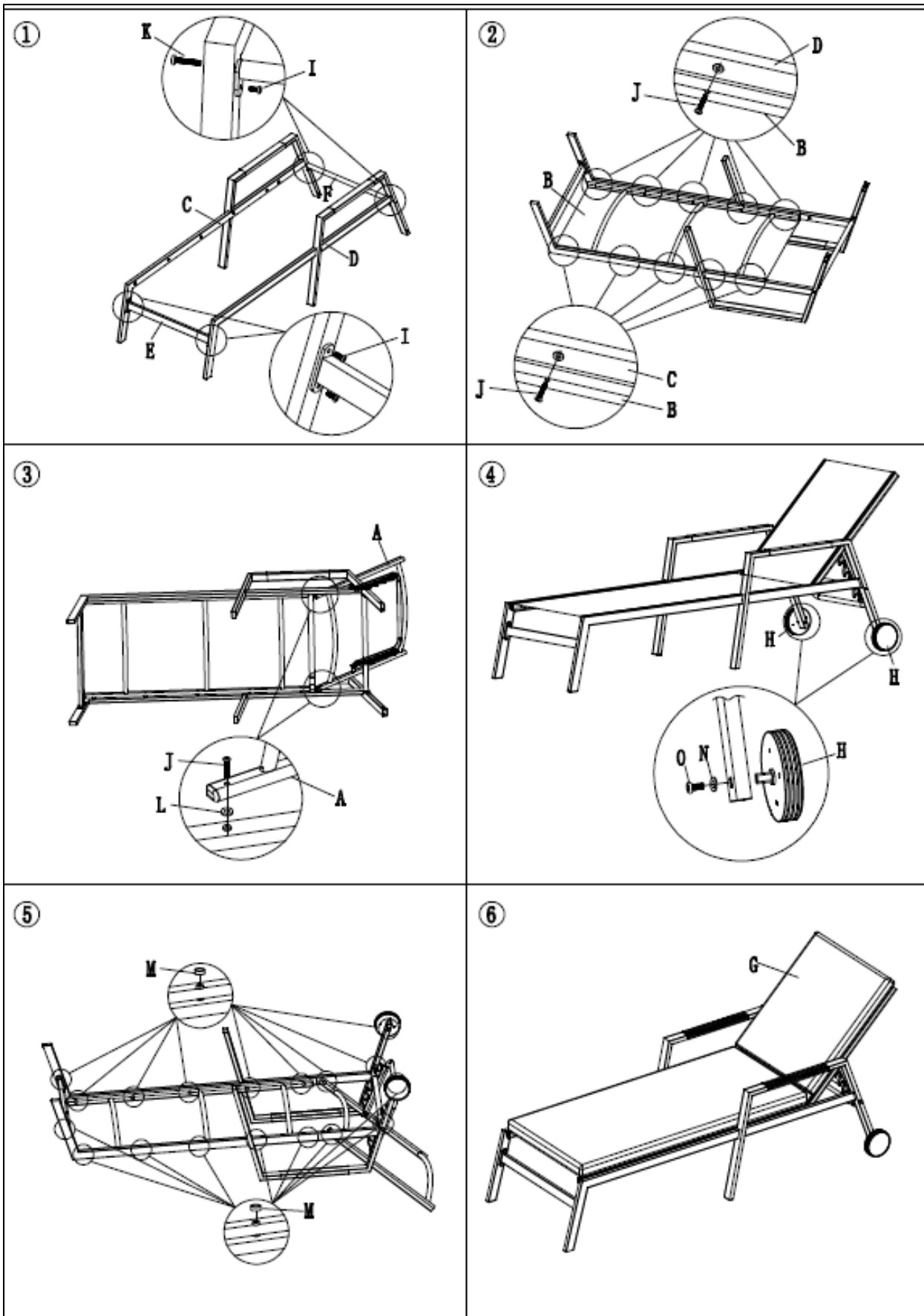

CARE INSTRUCTIONS

- To clean, wipe with a sponge and warm, soapy water then wipe with a dry, clean cloth. Do not use solvent-based cleaners or detergents as they can bleach or damage the product.
- Never use a pressure hose or washer to clean the product. Never use scourers, abrasives or chemical cleaners.
- To help maintain its appearance and avoid scratches, never place sharp pointed objects directly onto the surface.
- The metal is powder coated. Do not use a wire brush when removing dirt from this item as it may damage the paint leaving the surface open to corrosion.
- Never drag furniture when moving it. Always lift it.
- Store the furniture in a cool, dry place. Ensure that the furniture is clean and dry before putting into storage.
- We recommend the use of furniture covers to protect your product when not in use.
- During bad weather and winter months, the product should be stored in a cool, dry place.
- Please keep away from sources of extreme heat and naked flames.
- The warranty does not cover accidental damage/neglect or general wear and tear.

CONTACT

CUSTOMER SERVICES - EMAIL: CUSTOMER.SERVICE@DOBBIES.COM. TELEPHONE NUMBER: 0131 561 6406 OR CONTACT YOUR LOCAL STORE.

DOBBIES GARDEN CENTRES LTD, MELVILLE NURSERY, LASSWADE, MIDLOTHIAN, EH18 1AZ