

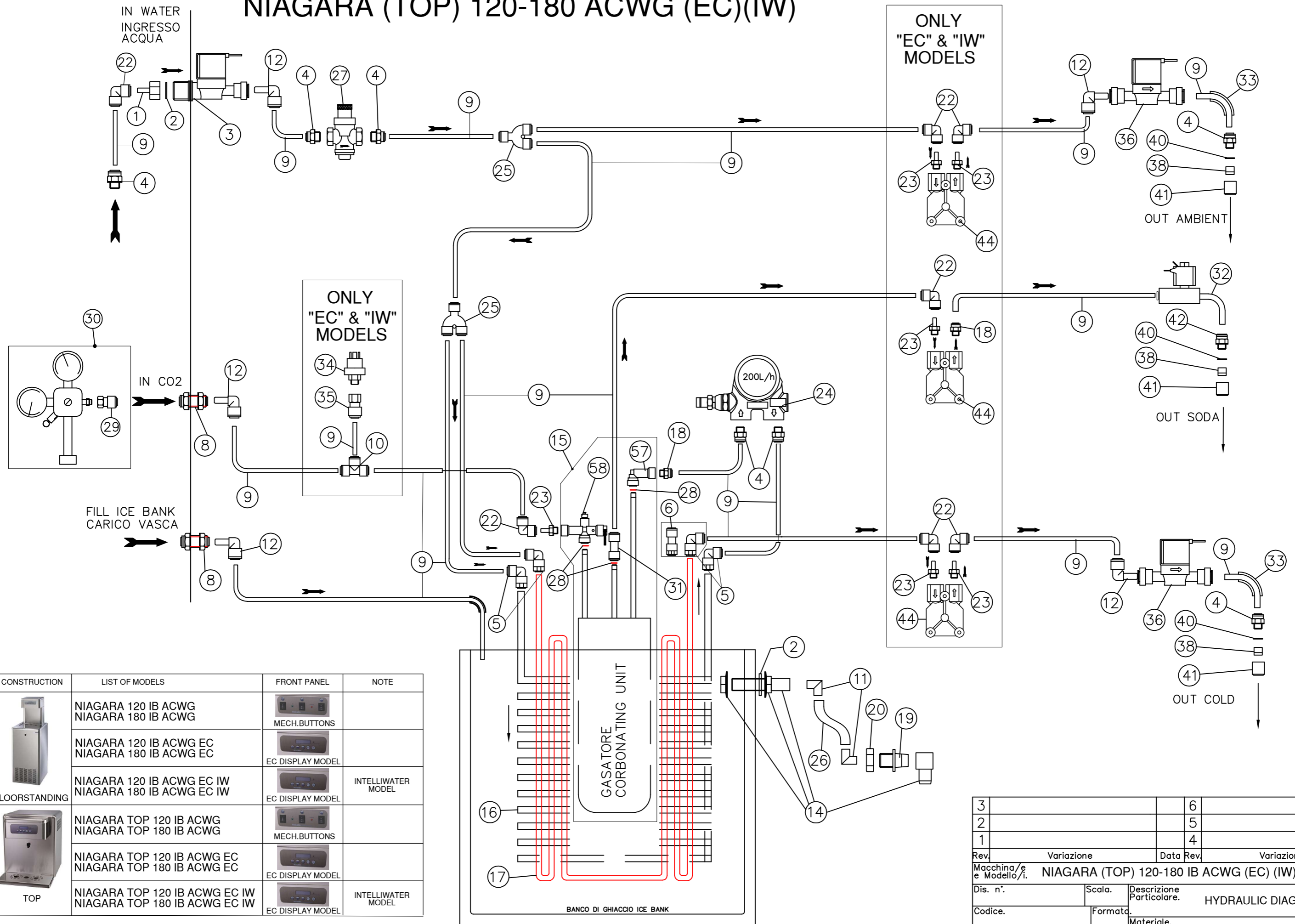





# NIAGARA (TOP) 120-180 ACWG (EC)(IW)

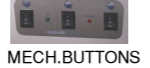

CONSTRUCTION	LIST OF MODELS	FRONT PANEL	NOTE
 FLOORSTANDING	NIAGARA 120 IB ACWG NIAGARA 180 IB ACWG	 MECH.BUTTONS	
	NIAGARA 120 IB ACWG EC NIAGARA 180 IB ACWG EC	 EC DISPLAY MODEL	
 TOP	NIAGARA TOP 120 IB ACWG NIAGARA TOP 180 IB ACWG	 MECH.BUTTONS	
	NIAGARA TOP 120 IB ACWG EC NIAGARA TOP 180 IB ACWG EC	 EC DISPLAY MODEL	INTELLIWATER MODEL
	NIAGARA TOP 120 IB ACWG EC IW NIAGARA TOP 180 IB ACWG EC IW	 EC DISPLAY MODEL	INTELLIWATER MODEL

3		6	
2		5	
1		4	
Rev.	Variazione	Data Rev.	Variazione
Macchina/e e Modello/i.		Data.	
Dis. n°.		03-07-2024	
Codice.	Scala.	Descrizione Particolare.	
	Formato.	HYDRAULIC DIAGRAM	
Materiale.			
Trattamento.			
Disegnato da.		Note.	
Nome File .DWG.			

## NIAGARA (TOP) 120-180 IB ACWG (EC) (IW) HYDRAULIC

POS	P/NUMBER	DESCRIZIONE 	DESCRIPTION 
1	304387	RACCORDO INGRESSO 3/4F-CODOLO 8	INLET FITTING 3/4F-STEM8
2	304953	GUARNIZIONE	GASKET
3	209443	SAFETY VALVE 24V 3/4M-JG8	SAFETY VALVE 24V 3/4M-JG8
	121291	ELETTROV. ALTERNATIVA CEME 24V 3/4M-JG8	ALTERNATIVE CEME SAFETY VALVE 24V 3/4M-JG8
4	007363	STRAIGHT ADAPTOR 3/8M-8 PM010813E	STRAIGHT ADAPTOR 3/8M-8 PM010813E
5	039747	GOMITO SUPERSEAL 5/16 SM030808S	ELBOW SUPERSEAL 5/16 SM030808S
6	056183	DRITTO SUPERSEAL 5/16 SM040808S	STRAIGHT SUPERSEAL 5/16 SM040808S
8	007444	PASSAPARETE 8-8 PM1208E	BULKEAD CONNECTOR 8-8 PM1208E
9	088113	TUBO LLDPE 8	LLDPE TUBE O.D. 8
10	046156	RACCORDO A T JG 8 PM0208E	TEE JG 8 PM0208E
11	208114	CURVA PICCOLA BIANCA	SMALL WHITE ELBOW
12	046469	GOMITO-CODOLO 8-8 PM220808E	STEM ELBOW 8-8 PM220808E
14	304380	RACCORDO DI DRENAGGIO	DRAINAGE FITTING
15	308960	GASATORE CON ALETTE SALDATE	CARBONATING UNIT WITH BRACKETS
16	302638	180 SERPENTINA INOX	180 ST.STEEL SERPENTINE
	302637	120 SERPENTINA INOX	120 ST.STEEL SERPENTINE
17	302694	SECONDA SERPENTINA INOX 180 WG	SECOND ST.STEEL SERPENTINE 180 WG
	300098	SECONDA SERPENTINA INOX 120 WG	SECOND ST.STEEL SERPENTINE 120 WG
18	007362	RACC. DRITTO 1/4M-8 PM010812E	STRAIGHT ADAPTOR 1/4M-8 PM010812E
19	304405	RACCORDO DI DRENAGGIO	DRAINAGE CONNECTOR
20	306681	DADO DA 1/4	BRASS NUT 1/4
22	067392	RACC. A GOMITO 8-8 PM0308E	EQUAL ELBOW 8-8 PM0308E
23	304349	RACCORDO DRITTO 1/4M-CODOLO 8 PM050812E	HOSETAIL ADAPTOR 1/4M-8 PM050812E
24	207937	POMPA DI OTTONE 3/8FF 200 L/H	BRASS PUMP 3/8FF 200 L/H
25	007050	RACCORDO A Y 8 PM2308S	Y FITTING 8 PM2308S
	069514	RACCORDO A Y 8 ALTERNATIVO RM2308E	ALTERNATIVE Y DIVIDER 8 RM2308E
26	272097	TUBO SILICONE	SILICON TUBE
27	208095	RIDUTTORE PRESSIONE PER ACQUA	WATER PRESSURE REDUCER
28	053845	CLIP 5/16	CLIP 5/16
29	011299	RACCORDO DRITTO 7/16F-8 PM4508F4S	STRAIGHT ADAPTOR 7/16F-8 PM4508F4S
30	304433	RIDUTTORE DI PRESSIONE CO2 DOPPIO MANOMETRO	CO2 PRESSURE REDUCER DOUBLE GAUGE
31	068555	RACCORDO DRITTO 8-8 PM0408E	STRAIGHT CONNECTOR 8-8 PM0408E

# NIAGARA (TOP) 120-180 IB ACWG (EC) (IW) HYDRAULIC

POS	P/NUMBER	DESCRIZIONE 	DESCRIPTION 
32	304844	ELETTRIVALVOLA PER GASSATA 24VAC JG.8	SPARKLING SOL. VALVE 24VAC JG.8
33	011256	CURVA PIEGATUBO 8 PM2608S	FLOW BEND CLIP 8-8 PM2608S
34	306527	PRESSOSTATO PER CO2	CO2 PRESSURE SWITCH
35	304288	ADATTATORE DRITTO 1/4F-8 PM450812E	STRAIGHT ADAPTOR 1/4F-8 PM450812E
36	208893	ELETTROV. RPE BASSA TENSIONE JG8 IN -OUT	SOLENOID VALVE RPE LOW VOLTAGE JG8 IN -OUT
	226274	ELETTROV. EKI ALTERNATIVA24V JG8 IN -OUT	ALTERNATIVE EKI SOLENOID VALVE 24V JG8 IN -OUT
38	304252	AERATORE	AERATOR
40	304943	PICCOLA GUARNIZIONE AERATORE	GASKET FOR PERLATOR
41	304251	BECCUCCIO INOX	INOX NOZZLE
42	304337	RACC. DRITTO 3/8M-10 PM011013E	STRAIGHT ADAPTOR 3/8M-10 PM011013E
44	208127	CONTALITRI IN PLASTICA 1/4FF	PLASTIC FLOWMETER 1/4FF
57	304369	RACCORDO INGRESSO H2O	H2O INLET FITTING
	304410	VALVOLINA DI NON RITORNO DW10	CHECK VALVE DW10
58	304368	RACCORDO INGRESSO CO2	CO2 INLET FITTING
	304902	SONDE 112 mm + SONDE	PROBE 112 mm
	207944	VALVOLA DI SFIATO	SAFETY PRESSURE VALVE
	304410	VALVOLINA DI NON RITORNO DW10	CHECK VALVE DW10

**03-07-2024**